

ELEVATION

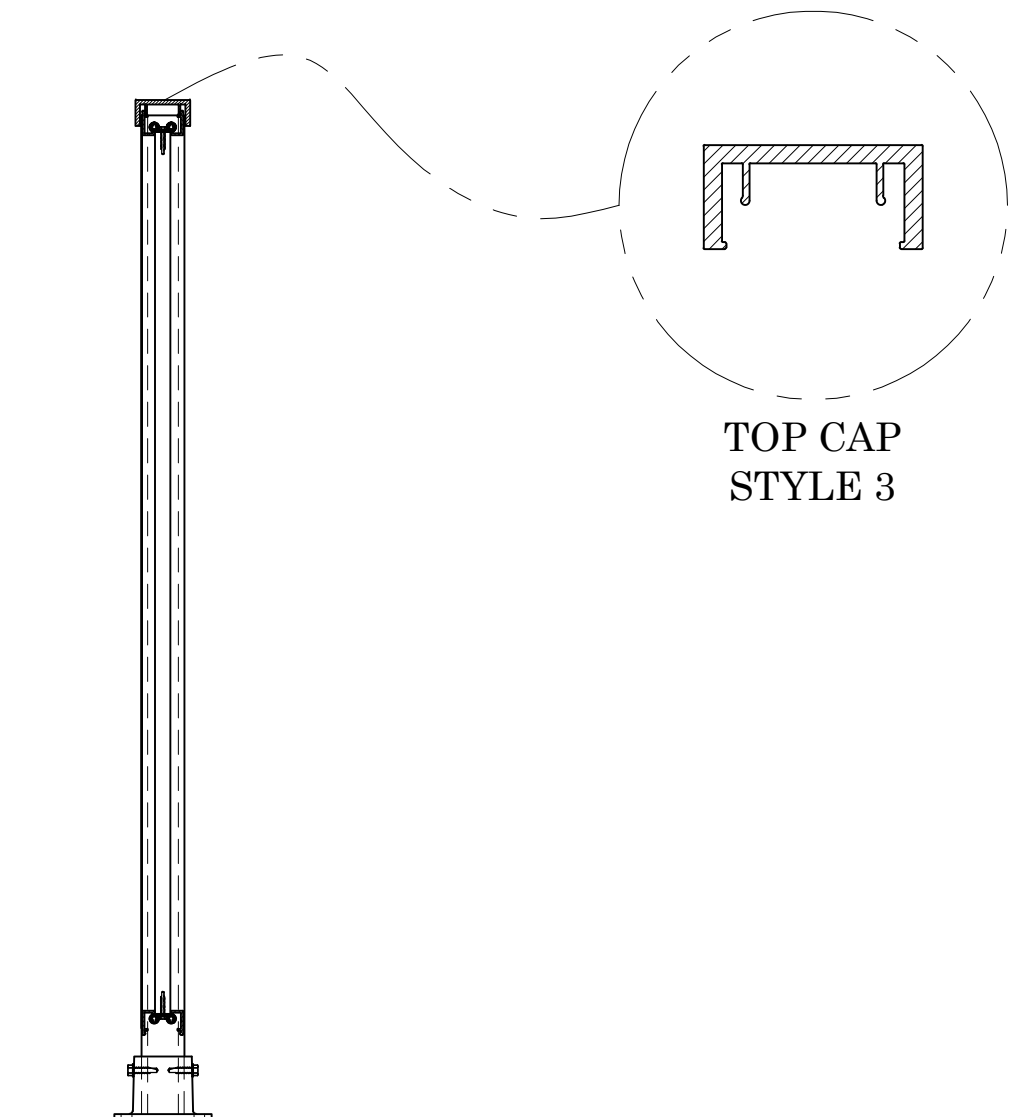

CUT-SECTION

TOP CAP
STYLE 3

M200-3A MATERIALS	
TOP CAP	2 1/4" x 1" TOP CAP (STYLE 3)
POST	1 3/4" SQUARE POST
CHANNEL	1 5/8" x 1" CHANNEL
PICKET	5/8" SQUARE PICKET (STYLE A)

POST MOUNTING OPTIONS	
SURFACE MOUNT	
SIDE MOUNT	
CORE-IN	



8301 Strimple Rd.
Cleveland, Ohio 45002
p 513 353-1116
f 513 353-2116

M-SERIES ALUMINUM RAILING

DESIGN# M200-3A

DRAWN BY:	DTB	REVISIONS:
DATE:	03/24/2022	
SCALE:	NOT TO SCALE	
SHEET #:	M200-3A	