

# ALUMINA RAILING COLOR CARD

## POWDURA® ARCHITECTURAL ALUMINUM COATING SYSTEMS

Designed to provide substantial resistance to abrasion, impacts, scuffing and scratching, Powdura 4000 coatings deliver a superb finish and long-term durability. This proven technology withstands harsh elements from UV rays to high heat and humidity. Powdura 4000 coatings are designed to meet or exceed AAMA 2604 specifications, giving your structure's metal products excellent gloss retention and weathering resistance.

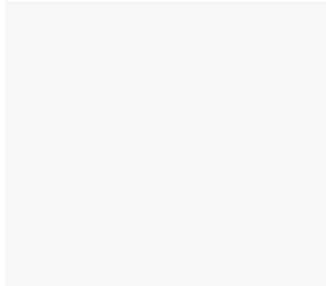

Coastal White  
DWS6-60017



Anodized Silver  
DSZ4-60009



Silverstorm  
JAM3-60000



Westchester Gray  
JAS3-V0003

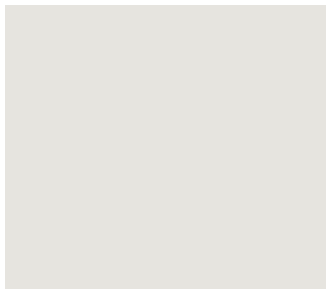

Linen  
JHS3-V0001

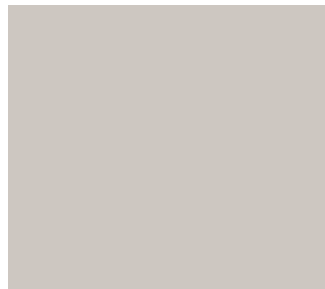

Overcast  
JAS3-V0002



Sandstone  
DHS2-80004

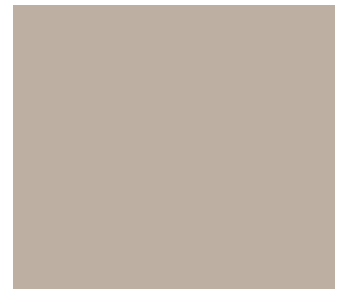

Paleo Bone  
JHS3-V0002

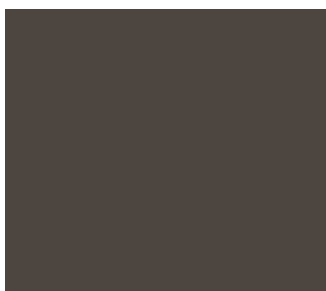

Bronze  
JDS3-V0001

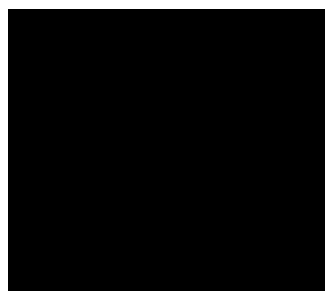

Satin Black  
JBS3-60005



Forest Green  
DGS2-80001

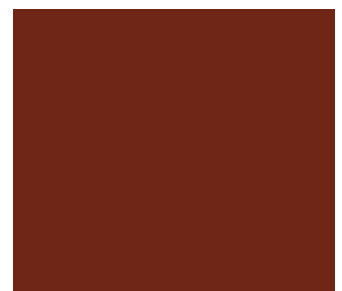

Revolutionary  
JRS3-V0002



PROUDLY FINISHED WITH  
**SHERWIN-WILLIAMS®**  
COATINGS



## TESTING INFORMATION ON ALUMINUM

	POWDURA® 3000	POWDURA® 4000
AAMA Spec	2603	2604
Film Thickness ASTM D7091	1.8 to 3.0 mil	1.8 to 3.0 mil
Specular Gloss at 60° ASTM D523	30-90 units	30-90 units
Humidity ASTM D2247	1,500 hours aluminum	3,000 hours aluminum
Acid Salt Spray ASTM G85 Annex 5	N/A	N/A
Salt Spray ASTM B117	2,000 hours	3,000 hours
Weathering	1 year exposure, 45° South Florida	5 years exposure, 45° South Florida
Fade ASTM D2244	Slight color fade	Max 5ΔE
Chalk ASTM D4214	Chalk minimal	Chalk maximum 8 rating
Gloss ASTM D523	Slight gloss loss	Gloss > 30% retention

## SHERWIN-WILLIAMS APPROVED APPLICATOR PROGRAM

Our established audit and testing program ensures that applicators meet Sherwin-Williams specifications and those of the American Architectural Manufacturers Association (AAMA) when applying Powdura coatings. Throughout the Approved Applicator Program's process, our technical service team works directly with applicators, assuring the highest performance and the desired aesthetic look of your finished product.

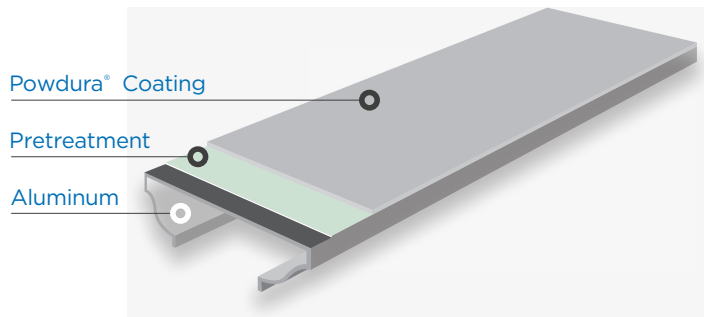

Since 1866, Sherwin-Williams has provided manufactures and finishers with the coatings they need to make their products look better and last longer, while helping their operations meet productivity and sustainability goals. For our general industrial markets, our innovative solutions go beyond coatings to include knowledge, tools, equipment, supplies, and industry-leading support. For a better finish, ask Sherwin-Williams.

© 2023 The Sherwin-Williams Company